

DESIDERIO

AUTO

STEAM/SUCTION ¥ AUTOMATIC FILLING ¥ 120V-60Hz

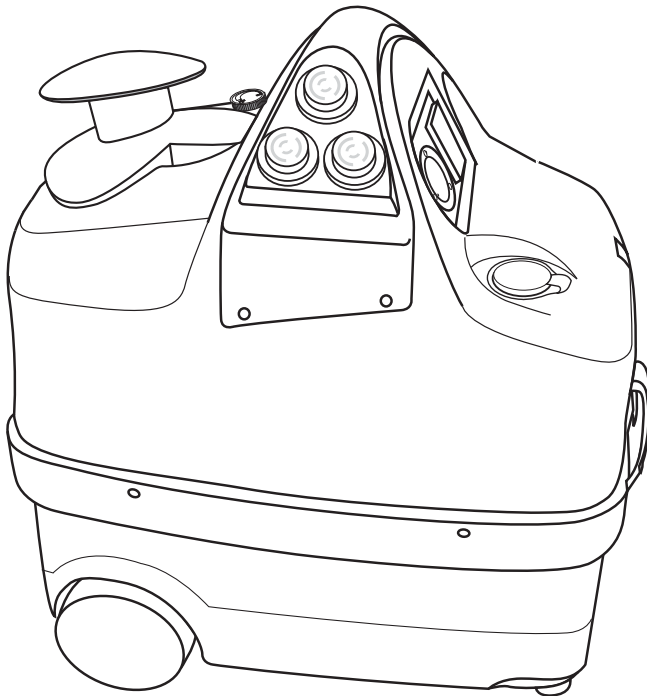

INSTRUCTIONS MANUAL

TECHNICAL FEATURES

Automatic boiler filling	
No Water buzzer	
Low voltage controls	
Power supply	120V - 60 Hz
Max power	1750 W
Boiler element	1000 W + 700 W
Operative pressure	max 75 psi
Vacuum power	1000 W 2-stage tangential
Max vacuum	21 kPa
Air-flow	46 litres/second
Boiler rated capacity	1,5 litres
Water tank capacity	1,5 litres + no water buzzer

IMPORTANT SAFETY INSTRUCTIONS READ AND FOLLOW ALL INSTRUCTIONS

Before attempting to operate the appliance, make sure you read and understand these instructions for use. Any use of the appliance deviating from that specified in this booklet is regarded as improper. The manufacturer disclaims all liability for damages resulting from improper use of the appliance; in this case, the only person responsible shall be the user.

Instructions, drawings, tables and any other material contained in this booklet is confidential technical material. No information, either in whole or part, may be reproduced or handed over to third parties without the prior written permission of the manufacturer, who is and remains the exclusive owner of such materials.

Dear Customer,

The appreciation you have shown in purchasing this appliance deserves much more than a simple thank you note.

Your purchase is an important expression of confidence and we are very grateful about that. How can we best reward your choice? By assuring you that, you have purchased a machine combining attractive design and excellent performance.

We have put all our experience at your service to provide you with a piece of equipment that will help you solve all your cleaning problems, both domestic and heavy duty.

Our appliances have been studied to the slightest detail to combine leading-edge design with maximum functionality. To obtain long-lasting durability out of your appliance, you will only need to provide a minimum level of care and observe the maintenance instructions given in this manual.

The boiler construction is 18/10 stainless steel with thickness grade 12/10. APPROVED. Inner component parts are of professional standard because they are all exceptionally high quality.

- The appliance is equipped with the following safety devices:
Cap with integrated safety valve
Boiler limiting device

- The distinctive feature of our appliances is their ease of use combined with economical operation.

- With the help of our cleaning accessories, you can use the power of steam to thoroughly clean and sanitize your living environment. Once you have applied steam-cleaned a surface, you can vacuum off the dirt. This extraordinary feature will save you an enormous amount of work and provide you with a perfect result.

We reserve the right to make any changes to the design and manufacture of the appliance as may be necessary from time to time as a result of technological advances.

2002/96/CE (RAEE)

PRECAUTIONS TO BE TAKEN WHEN OPERATING THE MACHINE

Before attempting to operate the Steam generator – Vacuum cleaner, read these instructions for use. The Manufacturer disclaims all responsibility for any injury to people or damage to property arising from failure to adhere to the instructions in this manual or from improper use of the appliance. Keep these instructions for use in a safe place

- Make sure that the electrical installation (120V- 60Hz) is earthed and equipped with differential switch, as required by applicable safety regulations **(Fig. 1)**
- Do not tug at the lead or at the appliance to pull the plug out from the socket **(Fig. 2)**
- Disconnect the plug from the socket before filling the tank with water.
- Do not use the appliance in gas-saturated environments.
- Do not vacuum flammable, explosive or corrosive substances.
- Do not use distilled water and do not introduce detergents or chemicals in the boiler.
- Let the water cool down before emptying the boiler
- To avoid any steam leak make sure that the boiler fill cap is properly tightened.
- Do not leave the appliance running unattended. ALWAYS switch it off before moving away from it.
- Before attempting to perform any maintenance or cleaning operation, ALWAYS unplug the appliance.
- Do not touch the appliance with damp or wet hands or feet when the appliance is plugged.
- Under no circumstances should the appliance be immersed in water or other fluids.

Use a damp cloth to clean the appliance. Avoid using solvents or detergents as these may damage the shell of the appliance.

- Under no circumstances should the steam jet be directed towards people, animals, or other electrical appliances **(Fig. 3)**.
- Use only extension leads that are proportioned to the load to avoid safety hazards and any dangers for the operator.
- Always call a retailer or an authorised technician to have the temperature limiting device replaced and in case of failures or malfunctions. Do not attempt to disassemble the appliance.
- The appliance generates steam at temperatures up to 130°C. Avoid any direct contact between your skin and steam **(Fig.4)**.

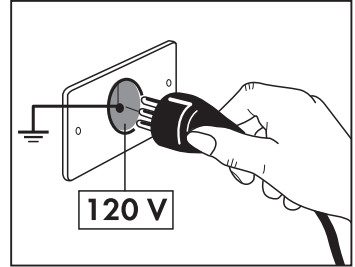

Fig. 1

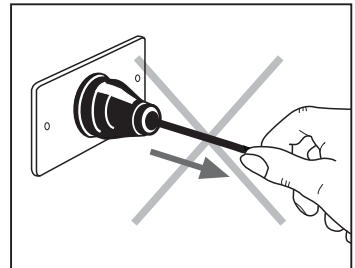

Fig. 2

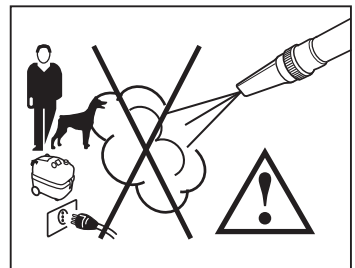

Fig. 3



Fig. 4

SAVE THESE INSTRUCTIONS

NOTICE

Any repair or service to the supply lead should only be carried out by authorised service centre personnel.

THE INSIDE OF THE APPLIANCE SHOULD ONLY BE SERVICED BY AUTHORIZED SERVICE CENTRES

SAFETY PRECAUTIONS

IMPORTANT

The power of steam substitutes for all detergents. It cleans but also provides the added advantage of sanitizing your living environments.

The steam generated by the boiler can reach a temperature; before cleaning any surface, we recommend you first check if the surface can withstand high temperatures. You may want to do a preliminary test on small samples or concealed parts of the surface.

- Use the appliance in its horizontal position. Never keep the machine in an upright position while the appliance is in operation.
- Additives may leave deposits in the boiler. You should never introduce soaps, perfumed essences or other chemicals in the boiler.
- Electrical appliances (TVs, radios, lamps), whether plugged or unplugged, should never be steam-cleaned.
- The appliance should not be used by children. Anyone using the appliance should be familiar with the instructions for use.
- Do not touch parts of the machine which may be very hot (e.g.: brushes and extensions)

NOTE

Our appliances are made in compliance with applicable regulations concerning electrical appliances.

Under unfavourable power supply conditions, the appliance can cause temporary voltage drops.

PACKAGING

Remove the appliance and the relative accessories from the packaging and put them in an appropriate place.

The original packaging has been designed to protect the appliance during shipment. We suggest you keep the packaging for future use.

Packing materials should be kept out of children's reach as they may pose a hazard

OPERATING THE STEAM/VACUUM APPLIANCE

KEY TO MACHINE COMPONENTS

1. Body of the machine
2. Recovery tank
3. Transfer handle
4. Power cable
5. Boiler pressure gauge
6. Recovery tank latches
7. Red warning light – no water in boiler
8. Green warning light – temperature ready
9. Water fill cap
10. Main switch
11. Boiler switch super power 1000 W
12. Boiler switch 700 W
13. Overfilling probes in recovery tank. When the recovery tank is overfilled, the probes (13) will automatically stop the motor. In this case, you need to restart the appliance.
14. Steam control knob
16. Accessories socket
17. Rear blow socket
18. Steam delivery/injection button (on handle)
19. Vacuum control button
(you can increase suction power by keeping the button pressed)

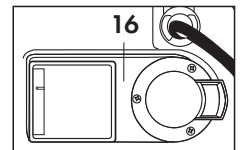
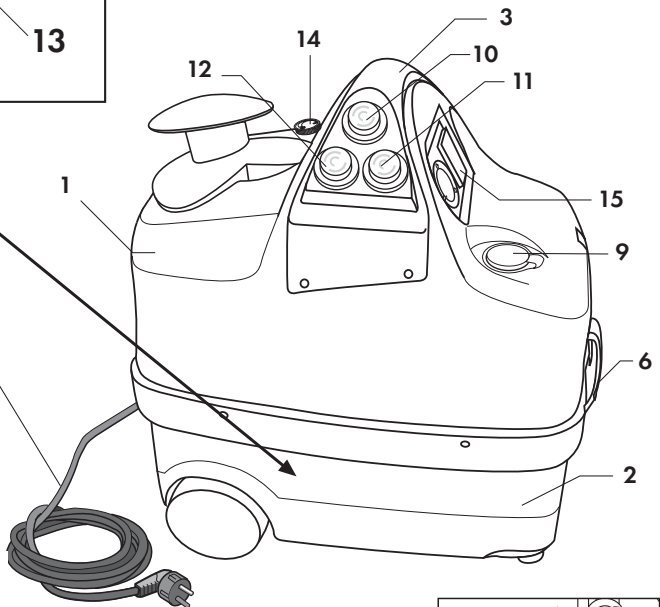
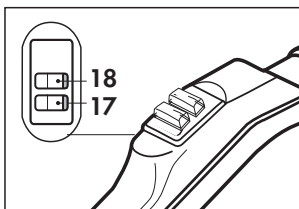
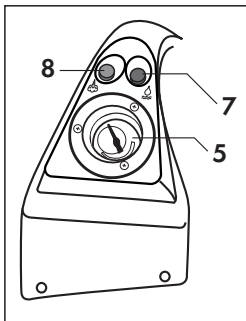
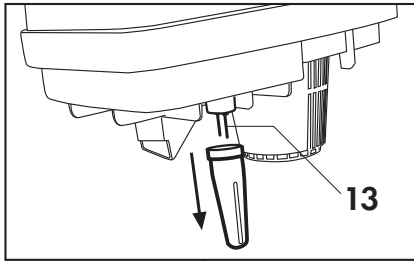

ACCESSORIES

19. Dual control handle, hose and multipurpose socket
20. Boiler fill bottle
21. 2 extension tubes
22. Textiles tool
23. Multipurpose brush
24. Bristled frame for fitted and non-fitted carpets (multipurpose brush)
25. Bristled frame for floors (multipurpose brush)
26. Window-wiping brush
27. Nozzle
28. Curved end for nozzle
29. 3 half crevice brushes for nozzle
30. 1 crevice brush for curved nozzle
31. Brush with soft + stiff round and triangular inserts
32. Muffler
33. Spare O-ring kit
34. Rotating vacuum brush
35. Brush with clear cover

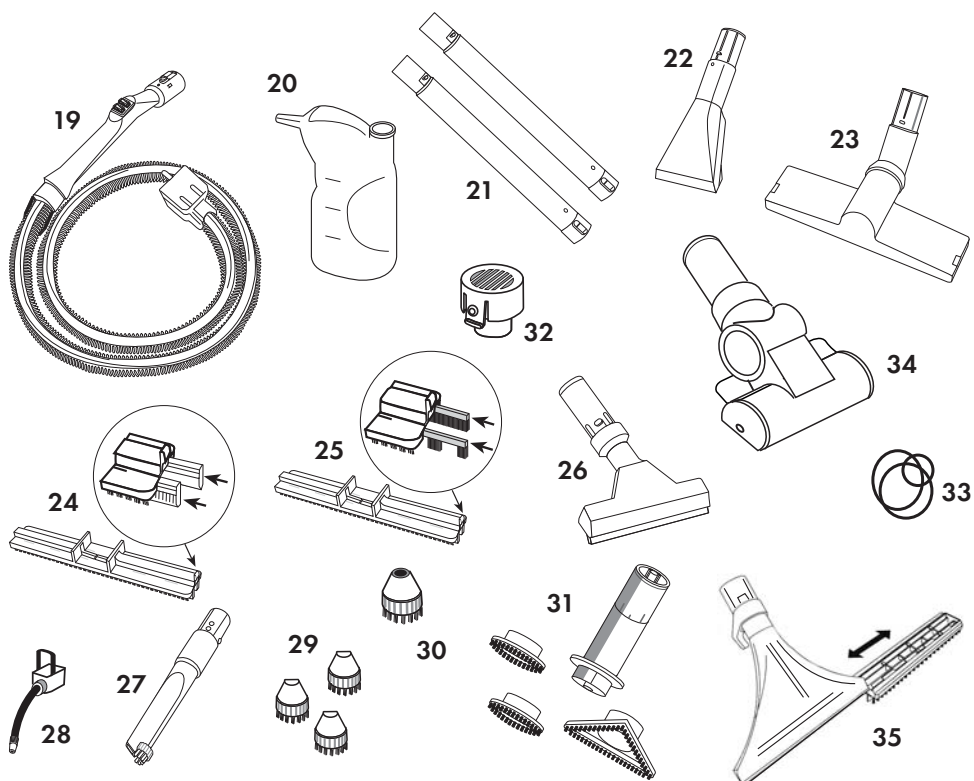

GENERAL OPERATING INSTRUCTION

FILLING THE BOILER

Fill the bottle (20) with filtered tap or bottled water.

Do not use distilled / demineralized water (Fig. 5).

Open the water fill cap (9) by hand; turn the bottle upside down with the top over the tank hole and empty the contents of the bottle into the tank. When the tank is full, close the cap (9) (Fig. 6)



Do not fill the boiler with a detergent-based solution, as this may lead to permanent boiler damage.

FILLING THE RECOVERY TANK

To provide more efficient suction, put 1,5 litres of water into the recovery tank (2). This will ensure that the air is filtered and any foreign material (dust, germs etc.) is trapped in the tank.

To ensure smooth functioning of the appliance, do not exceed the specified amount of water. (Fig. 7)

When the tank is full, the motor will stop automatically. Switch OFF, empty the tank and refill with fresh water.

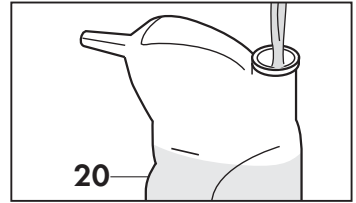

Fig. 5

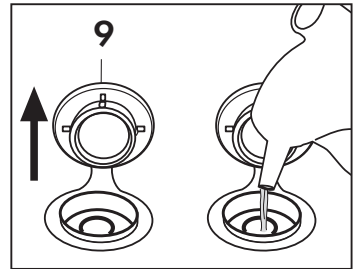

Fig. 6

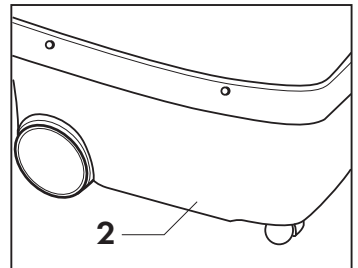

Fig. 7

CONNECTING THE SUCTION/INJECTION HOSE (19)

Pull the accessories socket door (15) wide open and plug the quick connection for the hose (19) into the socket on the front of the appliance; push the quick connection in as far as it will go. Close the accessories socket door (15) against the body of the quick connection and ensure that the two parts latch onto each other. (Fig. 8)

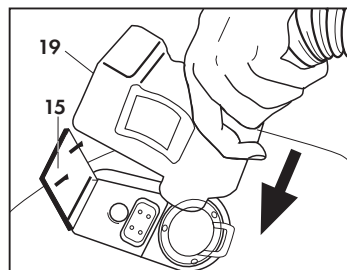

Fig. 8

ELECTRICAL CONNECTION

The connection of the steam/vacuum appliance to the mains supply must be in accordance with current regulations (for Italy, refer to Law no. 46/90). Check that the main voltage on the electric system matches the voltage the appliance has been engineered to run at. Electrical data can be found on the appliance identification plate (Fig. 9)

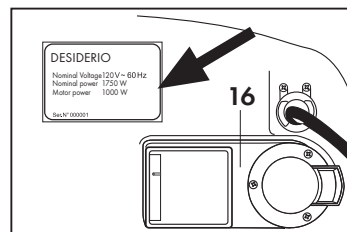

Fig. 9

 **The lead must be protected against inadvertent pinching. Non-compliance with the instructions above relieves the manufacturer from any and all responsibilities and is classified as careless use of the appliance.**

STARTING APPLIANCE STEAM - VACUUM

Make sure the button (17) and switches (18) on the handle (19) are OFF.
- Press the main switch (10) and the boiler switch (12) to turn the appliance and the boiler on. If more power is needed and in order to accelerate the heating process, press the boiler switch super power (11).

- Wait for the boiler to reach the appropriate operating pressure. When the green light (8) illuminates, the appliance is ready for use.

- Select the desired steam level with the appropriate control knob (14).

NOTE

Vacuum and steam power can be changed during machine operation. Under normal operating conditions, an illuminated green warning light will indicate that pressure in the boiler is within normal values; however, continual steam delivery causes pressure to decrease slightly; in this case, the warning light will switch off automatically until the operating pressure value is reached again. Even in this condition, you may safely continue with your cleaning job, since resistances in the appliance have been proportioned to provide immediate reinstatement of the operating pressure.

TURNING ON THE APPLIANCE IN THE VACUUM FUNCTION

Ensure that the switch (18) on the handle (19) is OFF.

Press the main switch (10) to switch ON the appliance in vacuum-cleaning mode. Now the appliance is ready for use.

HOW TO OPERATE THE APPLIANCE:

Before using the appliance, fit the desired tool to the hose handle (19). Once the tool is installed, use the controls on the handle to operate the appliance as fit.

Using the controls on the handle, you can:

- deliver steam, by pressing the red button (17);
- vacuum, by pressing the white button (18);

INSTRUCTIONS FOR USE

USING THE APPLIANCE TO CLEAN TEXTILES

Before treating textiles with the steam/vacuum appliance, check whether fabrics are steam-proof by testing a concealed portion of them.

Thoroughly steam the surface you want to test and let it dry. Once dry, check if shape or colour has changed.

USING THE APPLIANCE TO CLEAN COVERED OR PAINTED SURFACES



Never direct steam at glued corners, as strips may come off as a result of being in contact with steam. Do not use the appliance on wooden floors or unsealed parquet floors.

Pay attention when cleaning kitchen furniture, home furniture, doors, parquet floors, painted surfaces or surfaces covered with synthetic products!

Wax, French polish, synthetic coverings or paint may peel off, degrade or show spots if steam is applied on these materials for an extended length of time. We suggest you clean these surfaces only with a steamed cloth or steam them just briefly with a double-layer cloth.

USING THE APPLIANCE TO CLEAN GLASS SURFACES



In order not to damage the frame sealing, do not direct the steam flow at sealed points on glass surfaces.

When outside temperatures are low, especially in the winter, heat the glass surface before cleaning by briefly applying steam to it. This will offset any difference in temperature between outside and inside surfaces and reduce any stress that may lead to the breaking of the glass surface.



IMPORTANT

The power of steam substitutes for all detergents. It cleans but also provides the added advantage of sanitizing your living environments.

The steam generated by the boiler can reach a temperature of 130°C; before cleaning any surface, we recommend you first check if the surface can withstand high temperatures. You may want to do a preliminary test on small samples or concealed parts of the surface.

HOW TO USE ACCESSORIES

USING THE ACCESSORIES

The appliance is provided with a number of accessories to fulfil different needs. To connect or disconnect the different components, simply install or remove the male end to or from the female part. **(Fig.10)**. Choose among the set of standard accessories the ones that are most fit for the job.



All switches on the handle should be off when replacing the accessories.

Never replace the accessories while the appliance is delivering steam; danger of burns.

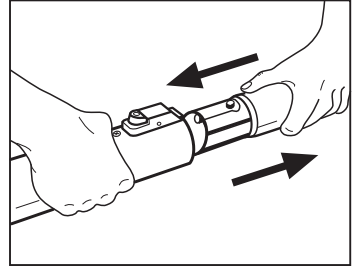

Fig. 10

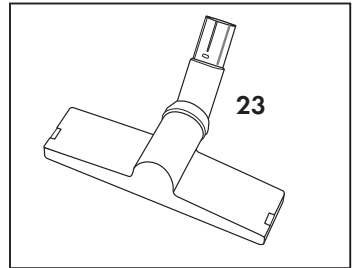

Fig. 11

MULTIPURPOSE BRUSH (23) Fig.11

This tool is fitted with a joint that allows the brush to rotate by 360°. Because of this particular feature, the multipurpose brush can effectively clean areas that are particularly hard to reach.

- The multipurpose brush consists of a universal element to which the following parts can be fitted as needed:
bristled frame for hard floors and surfaces. (25)
bristled frame for fitted and non-fitted carpets (24)

FITTING THE MULTIPURPOSE BRUSH (23)

To install the bristled frame for fitted and non-fitted carpets (24), introduce the stiff brushes into the appropriate guides with the tabs facing inwards (Fig. 12).

To fit the desired insert to the brush body simply place the insert against the brush body and press one against the other until the little lever on the outside of the brush body is fully engaged in the slot provided (Fig 13).

To remove the bristled frame, disengage the lever from the brush body.

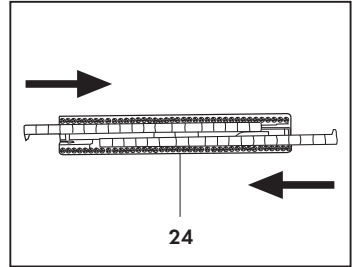

Fig. 12

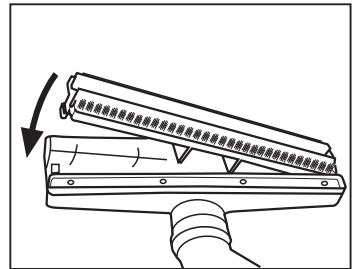

Fig. 13

NOZZLE (27)

Suitable for specific jobs. Use the nozzle to clean tile joints or seams in seats or sofas, where dirt is particularly stubborn.

TEXTILES TOOL (22)

A useful tool for cleaning sofas, armchairs, mattresses, car seats and particularly narrow areas where the multipurpose brush cannot reach.

WINDOW-WIPING BRUSH (26)

Particularly suitable for cleaning windows and mirrors. For correct use, follow the instructions below:

- Steam the surface you want to clean while keeping the bristles against the surface.
- Press the rubber blade onto the surface and vacuum any water on the surface by moving the tool vertically from top to bottom (Fig.14).

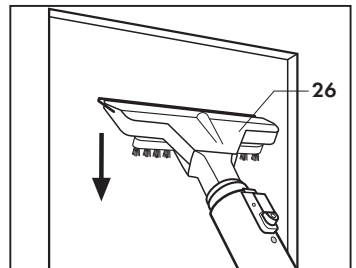

Fig. 14

EXTENSION TUBES (21)

Fit the extension tubes as needed and lock them into position. You may also use one single extension tube (Fig.15).

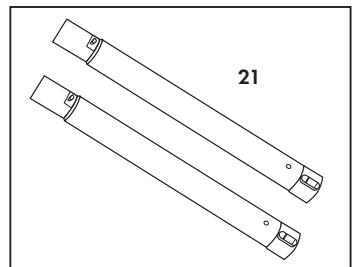

Fig. 15

WORK HOSE (19)

Press the vacuum control button (18) on the work hose to activate or deactivate the blowing function. Holding down the button will increase or decrease suction power (Fig. 16).



Only use original accessories, as these provide better quality and safety characteristics. Non-use of original accessories shall relieve the manufacturer from any responsibility.

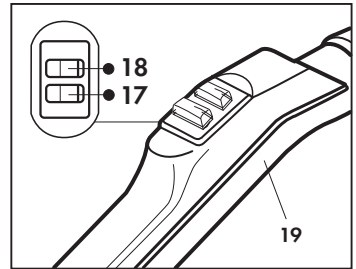

Fig. 16

ROTATING VACUUM BRUSH Fig. 17

This brush combines the cleaning action of steam with the powerful effect of vacuum generated by the motor and enables the operator to remove hairs, dust, and debris from all textile surfaces (loose and fitted carpets, sofas, car seats, etc.).

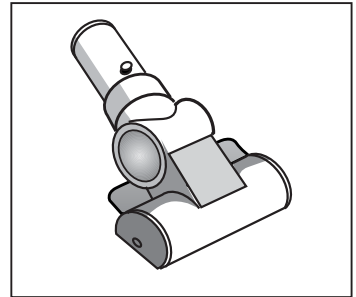

Fig. 17

ROUND BRUSH ASSEMBLY WITH SOFT, STIFF OR STIFF TRIANGULAR INSERTS Fig. 18

This brush can be attached to the handle or to the extension hoses and is ideal for vacuuming gaps. Three different inserts are available with soft or stiff bristles or triangular stiff bristles, which can be installed to the round brush assembly.

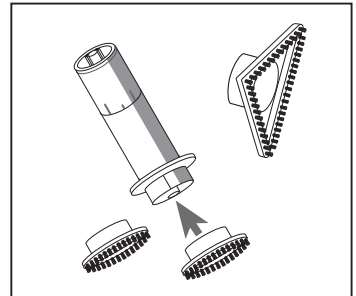

Fig. 18

STOPPING THE STEAM/VACUUM APPLIANCE

To stop the appliance, turn the steam and suction control switches on the handle (19) to the off position; move the switches on the appliance to the off position (Fig. 19) and disconnect the plug from the socket.

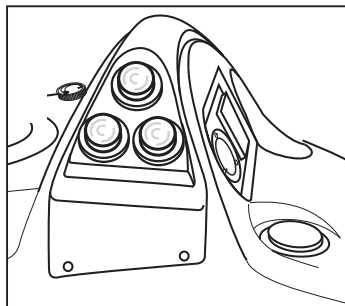

Fig. 19



Switch on and off the appliance only by using the switches, never by plugging and unplugging.



Never tug at the lead to disconnect the plug from the socket.

IMPORTANT NOTES

Your steam/vacuum appliance, like any technical appliance, must be used only in accordance with the instructions.

Materials such as concrete and masonry debris should not be vacuumed in the presence of moisture, as these materials may harden inside the recovery tank and cause incrustations that lead to filter damage and, eventually, to permanent motor damage.

The recovery tank must be cleaned regularly to ensure smooth running of the appliance and for hygienic reasons (bad odours, etc.).

Wear suitable protective gear (gloves, masks, etc.) before working on the recovery tank.

Vacuuming will stop automatically when the recovery tank (2) is full-up with dirt and liquids, and will not be resumed until the recovery tank (2) is emptied and the accessory switch (10) has been switched off and then on again.

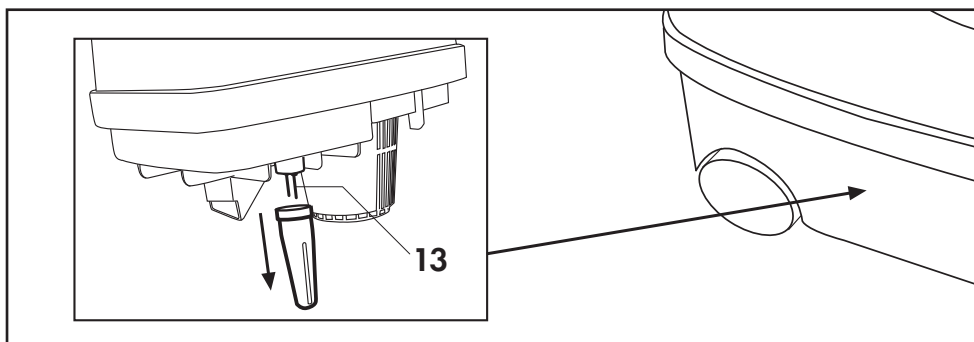

13. Overfilling probes in recovery tank. When the recovery tank is overfilled, the probes (13) will automatically stop the motor. In this case, you need to restart the appliance.

MAINTENANCE

BOILER MAINTENANCE

The boiler should be serviced on average every 300 hours of operation. If the appliance is used with particularly hard water (> 30 Fr), service the boiler at shorter intervals. Wash the boiler using a boiler de-scaling product (available from the manufacturer), carrying out the steps set out below. Do not use products other than those recommended for cleaning the boiler.



Maintenance should be performed with the appliance OFF and the power plug disconnected from the socket.

The boiler should be cleaned out on a regular basis (approximately every 300 hours of operation, or every 6 months). Wash the boiler with the de-scaling product (follow the instructions for use on the product package).



CLEANING THE RECOVERY TANK AND ACCESSORIES

Check the state of picked up matter on a regular basis. Empty and clean the recovery tank and the accessories after each use.

For better accessory efficiency, clean the O-rings on a regular basis.

Before attempting to clean the tank, you must deactivate the main switch, unplug the appliance, and wait for the machine to cool down. Do not immerse the appliance in water! It is absolutely forbidden to service the inside parts of the machine.

The recovery tank (2) should be cleaned on a regular basis to remove any fluid or contamination. Release the latches (6) and lift the top part of the appliance (1).

For cleaning, follow the instructions below:

- Empty the recovery tank (2).
- Fill a container with up to 3 litres of clean water. Disinfectants may be added as long as they are foam-free.
- Activate the vacuum function using the vacuum button (18) and draw water through the accessories previously used for cleaning.
- Empty the recovery tank (2) and repeat the operation as necessary.

Every time the bottom part of the appliance is cleaned, clean any solid residues off the outside of filter (A) **(Fig. 20)**.

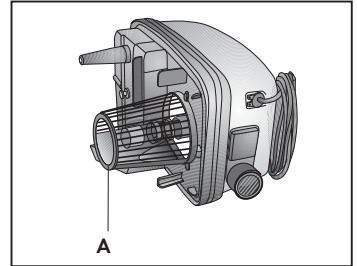

Fig. 20

CLEANING THE ACCESSORIES

Clean the accessories (extension hoses, multi-purpose brush, nozzle, textiles tool) with running water. It is advisable to use steam when cleaning the frames.

STOWAGE

When stowing the appliance away for long periods of time, you should first disconnect the steam/vacuum appliance from the mains supply by removing the plug from the socket. Then, empty and wash the waste recovery tank and clean the boiler. Also, take adequate precautions to protect any parts that may be damaged because of dust build-ups. When setting the appliance at work again, inspect the steam delivery / suction hoses and the accessories for cracks or slits.

SCRAPPING

Should you decide not to use the steam/vacuum appliance any longer, we recommend making the appliance inoperative by removing the power supply lead. We also recommend neutralizing all parts that may pose hazards, especially to children who may use the discarded appliance as a toy.

The steam/vacuum appliance is special waste; as such, it should be disassembled and divided into groups of parts of the same kind that should be disposed of in accordance to current regulations. Do not use scrapped parts as spare parts.

LEGAL NOTICE

¥ These instructions for use contain essential information for proper use and accurate maintenance of the appliance as well as information on machine functions.

¥ Understanding such information and adhering to the instructions given in this booklet is critical for hazardless, safe operation and maintenance of the appliance.

¥ Please contact your local retailer or the manufacturer if you require further information or if you notice problems that you feel have not been adequately covered by these instructions for use.

¥ Please note that the contents of this instruction manual are not part of any earlier or existing settlement, legal agreement or contract and that no future settlement, agreement or contract will alter the substance of the contents in this manual.

¥ All of the manufacturer's obligations are contained in the appliance sale agreement, which also contains full and exclusive terms and conditions of guarantee.

¥ All the terms of guarantee contained in the agreement are neither restricted nor extended based on these explanations.

¥ These instructions for use contain information protected by copyright.

¥ These instructions for use may not be photocopied or translated into another language without the prior written permission of the Manufacturer.

DISPOSAL OF THE APPLIANCE

¥ Appliances no longer in use should be made inoperative.

¥ Disconnect the plug from the socket and cut the electrical cable.

¥ Send any appliances no longer in use to an appropriate waste collection centre.

TROUBLES AND REMEDIES

TROUBLES	CAUSES	REMEDIES
The appliance is not functioning.	Power failure. Faulty cable or switches	Ensure there is power. Contact the Service Centre.
Water is coming out from the body of the machine (air outlet).	Recovery tank is too full.	Empty the recovery tank and check the float; clean float as needed.
Suction power has reduced noticeably	Clogged or broken hoses, tubes or accessories. Recovery tank is too full. Insufficient adherence to machine body.	Clean hoses, tubes or accessories or replace them. Empty the recovery tank. Check if machine body is secured to the recovery tank and check that the clips are fastened.
The motor is running fast (highpitched noise).	Clogged hoses, tubes or accessories. Recovery tank is too full.	Clean hoses, tubes or accessories. Empty the recovery tank.
Water leaking from accessories joints.	Joint seals worn or leaking.	Inspect, clean and lubricate seals; replace seals if necessary.
Accessories not fully engaging.	Dirt has deposited in the joints and quick connections.	Clean and lubricate the joints and quick connections.
No steam is coming out and suction is not working.	Boiler not yet under pressure (green light off). Power failure. Appliance plug is not in the socket.	Wait a couple of minutes for the green light to illuminate. If the problem is still there, contact one of our Service Centres. Check that power is available; check that the plug is properly connected to the socket. Check that the appliance plug is properly connected to the socket in the electric panel.

TROUBLES	CAUSES	REMEDIES
Little drops of water dripping from the accessories.	This condition is normal during the first minutes of operation; condensate will form because of a difference in temperature between the accessories and steam.	The inconvenience is normally eliminated after a few minutes of operation; If the trouble is still there, clean the boiler.
No water/detergent is delivered when the pump switches both on the appliance and on the handle are pressed..	No water or detergent is in the tank (15)	Add more water or detergent.

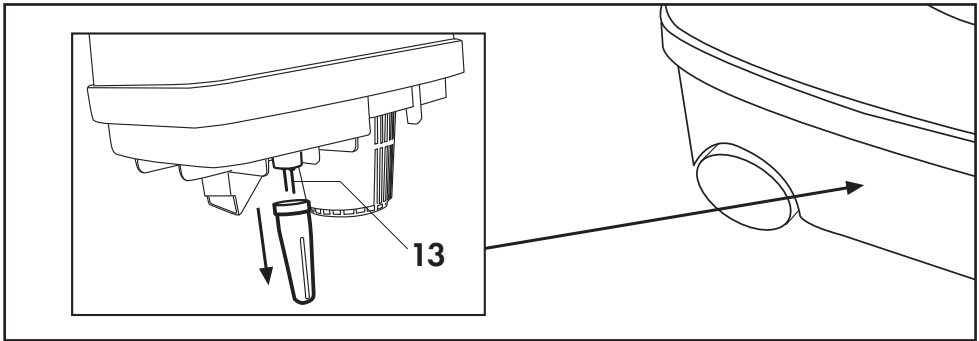

13 Overfilling probes in recovery tank. When the recovery tank is overfilled, the probes (13) will automatically stop the motor. In this case, you need to restart the appliance.

TROUBLES	CAUSES	REMEDIES
Suction is not working.	Recovery tank is full.	Switch off the appliance via the appliance switches. Empty the tank, clean the probes (X), and allow them to dry. If the problem persists, contact your Service Centre.



IMPORTANT INFORMATION FOR CORRECT DISPOSAL OF THE PRODUCT IN ACCORDANCE WITH EC DIRECTIVE 2012/19/UE

At the end of its working life the product must not be disposed of with urban waste. It may be delivered to special centres for separate waste collection organised by the municipality, or to dealers who supply this service. Separate disposal of an electric household appliance allows the avoidance of possible negative consequences for the environment and for health resulting from inadequate disposal and allows the recovery of the materials of which it is composed in order to obtain an important saving in energy and resources. The symbol of the crossed out bin is applied on the product to indicate that electric household appliance must be disposed of separately.

